

WHITE KORA MID SLEEPER BED ASSEMBLY INSTRUCTIONS

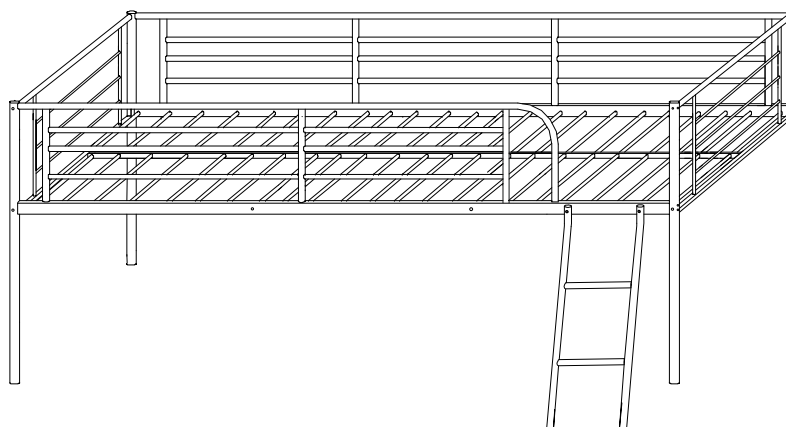

IMPORTANT FOR DOMESTIC USE ONLY

PLEASE READ AND FOLLOW THESE INSTRUCTIONS CAREFULLY

RETAIN FOR FUTURE REFERENCE

SAFETY WARNING

- All bunk beds and high beds intended to be assembled by someone other than the manufacturer or their representative shall contain assembly instructions a list of the parts supplied and details of any tools required to assemble the bed.
- We recommend that you use the mattress at size: 1900x900x160mm.
- All assembly fastenings should always be tightened properly and that care should be taken that no fittings are loose.
- Instructions regarding positioning and connection of the means of access.
- The ladder is not for playing on, only use to climb onto the top bunk.
- We recommend only one person on the upper bunk at one time.
- Warning:-** The bunk bed or high bed should not be used if any structural part is broken or missing.
- The top of the mattress shall be at least 160mm below the upper edge of the safety barriers.
- Warning:-** Children can become trapped between the bed and the wall to avoid risk of serious injury the distance between the top safety barrier and the wall shall not exceed 75mm or shall be more than 230mm.
- Warning:** Bunk beds and high beds can present a serious risk of injury from strangulation if not used correctly. Never attach or hang items to any part of the bunk bed that are not designed to be used with the bed, for example, but not limited to ropes, strings, cords, hooks, belts and bags.
- The ventilation of the room is necessary in order to keep the humidity low and to prevent mold in and around the bed.
- The manufacturer's instruction must be always followed.
- EN 747-1&2:2012+A1:2015 TEST version.

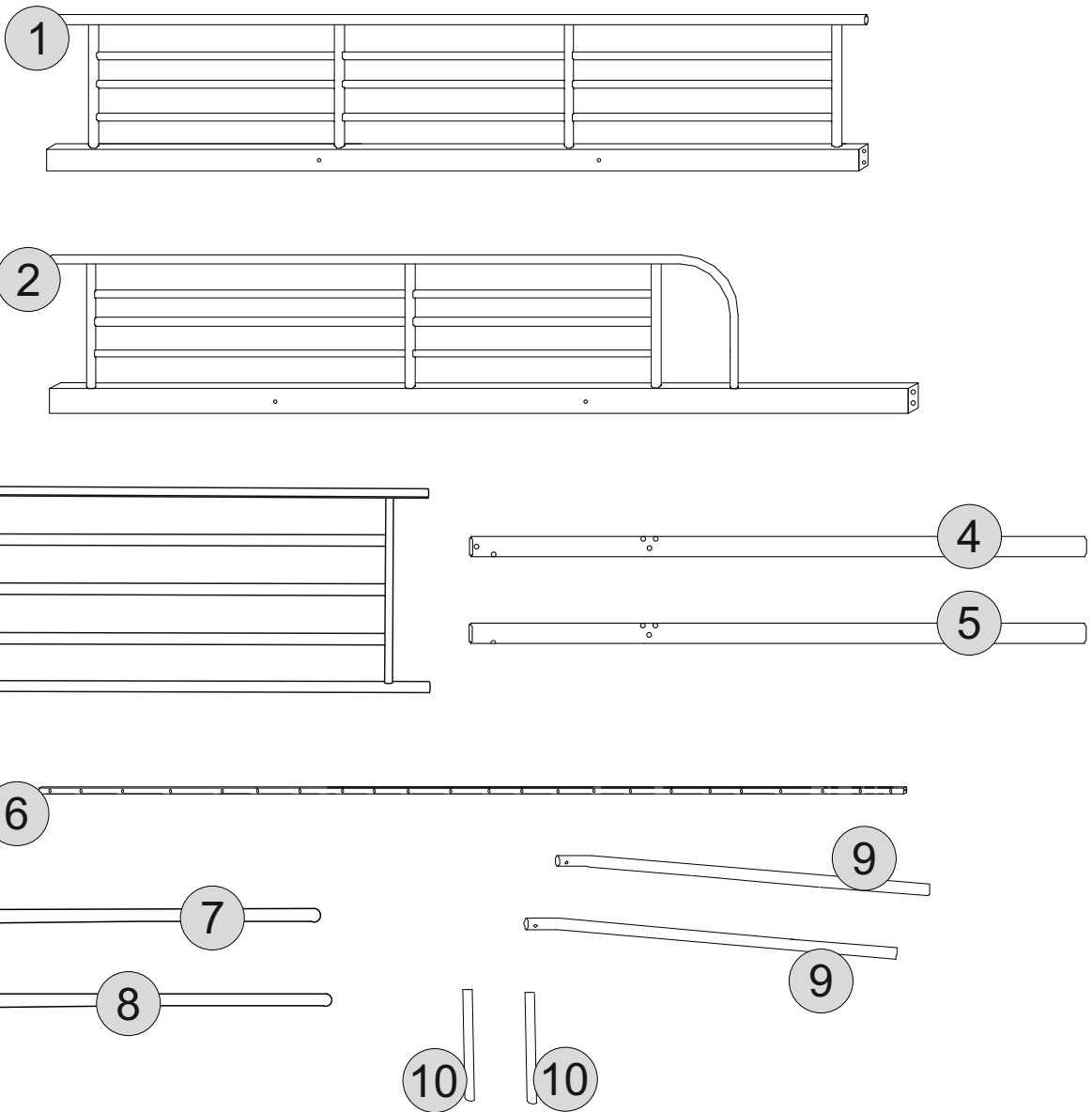









PLEASE CHECK THAT YOU HAVE ALL THE PARTS LISTED BEFORE YOU START ASSEMBLING. IF YOU DO FIND THAT SOMETHING IS MISSING, DO NOT CONTINUE ASSEMBLY. PLEASE CONTACT YOUR SUPPLIER IMMEDIATELY.

PARTS LIST

Part Number	Part Code	Part Description	Quantity	Carton
1	S200-206-020-RJ1-01	Back Guardrail	1	1
2	S200-206-020-RJ1-02	Front Guardrail	1	1
3	S200-206-020-RJ1-03	Headboard/Footboard	2	1
4	S200-206-020-RJ1-04	Bed Post	3	1
5	S200-206-020-RJ1-05	Bed Post (Front Right)	1	1
6	S200-206-020-RJ1-06	Centre Rail	1	1
7	S200-206-020-RJ1-07	Slats	21	1
8	S200-206-020-RJ1-08	Fixed Slats	2	1
9	S200-206-020-RJ1-09	Ladder Side	2	1
10	S200-206-020-RJ1-10	Ladder Steps	2	1

HARDWARE LIST

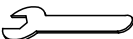
REF		HARDWARE NAME	QTY
A		Bolt M6x16mm	8PCS
B		Bolt M6x40mm	6PCS
C		Bolt M6x50mm	2PCS
D		Bolt M6x65mm	15PCS
E		Washer M6	6PCS
F		Washer M6	25PCS
G		Allen Key M4	1PC
H		Nut M6	2PCS
I		Spanner	1PC

**PLEASE CHECK THAT YOU HAVE ALL THE PARTS LISTED
 BEFORE YOU START ASSEMBLING. IF YOU DO FIND THAT
 SOMETHING IS MISSING. DO NOT CONTINUE ASSEMBLY.
 PLEASE CONTACT YOUR SUPPLIER IMMEDIATELY.**

STEP 1

PARTS REQUIRED

3 - HEADBOARD/FOOTBOARD x1

4 - BED POST x2

HARDWARE REQUIRED

A  02

D  02

F  04

TOOLS REQUIRED

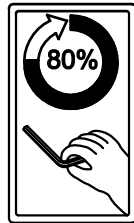
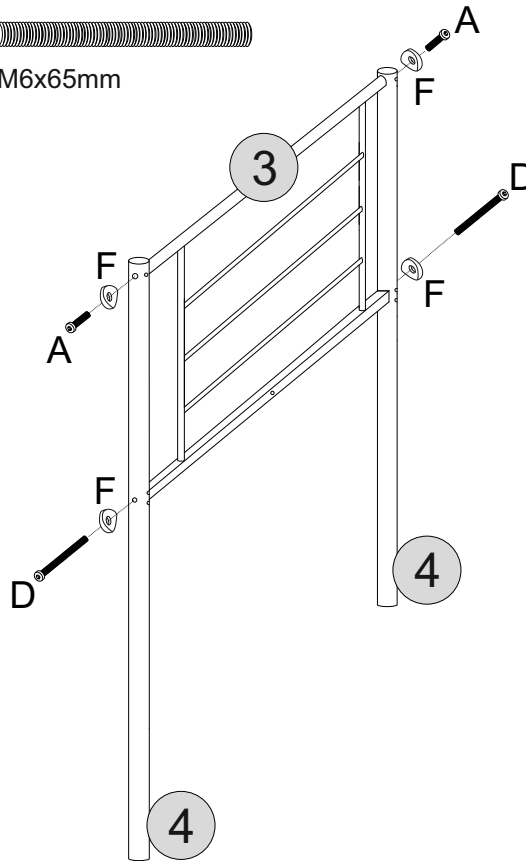
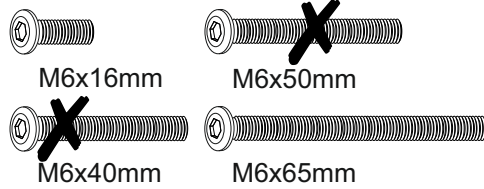

DO NOT FULLY TIGHTEN THE BOLTS AT THIS STAGE !!

STEP 2

PARTS REQUIRED

3 - HEADBOARD/FOOTBOARD x1

4 - BED POST x1

5 - BED POST (FRONT RIGHT) x1

HARDWARE REQUIRED

A  02

D  02

F  04

TOOLS REQUIRED

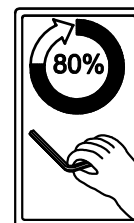
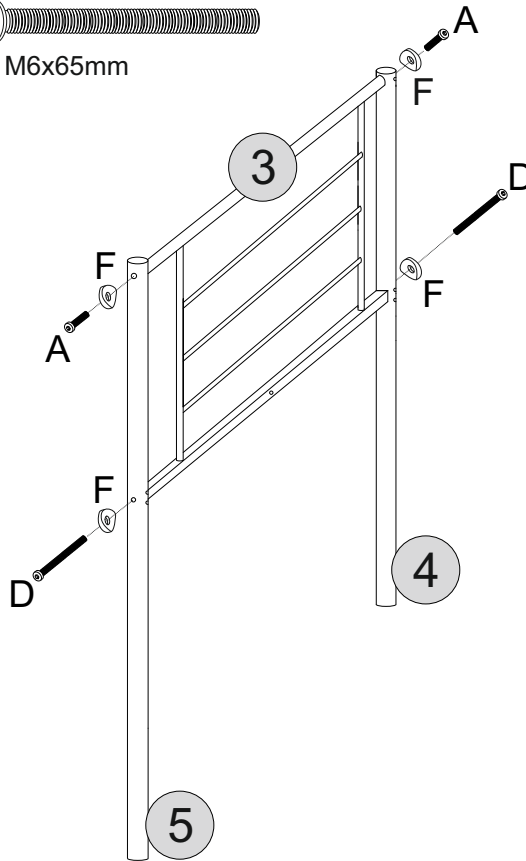
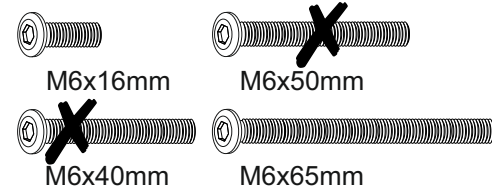

DO NOT FULLY TIGHTEN THE BOLTS AT THIS STAGE !!

STEP 3

PARTS REQUIRED

1 - BACK GUARDRAIL x1

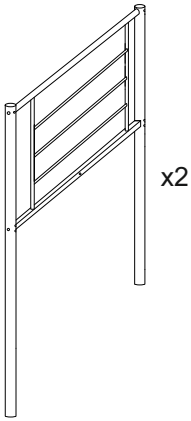

HARDWARE REQUIRED

D		06
F		06

TOOLS REQUIRED

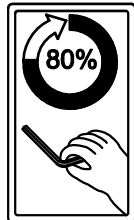
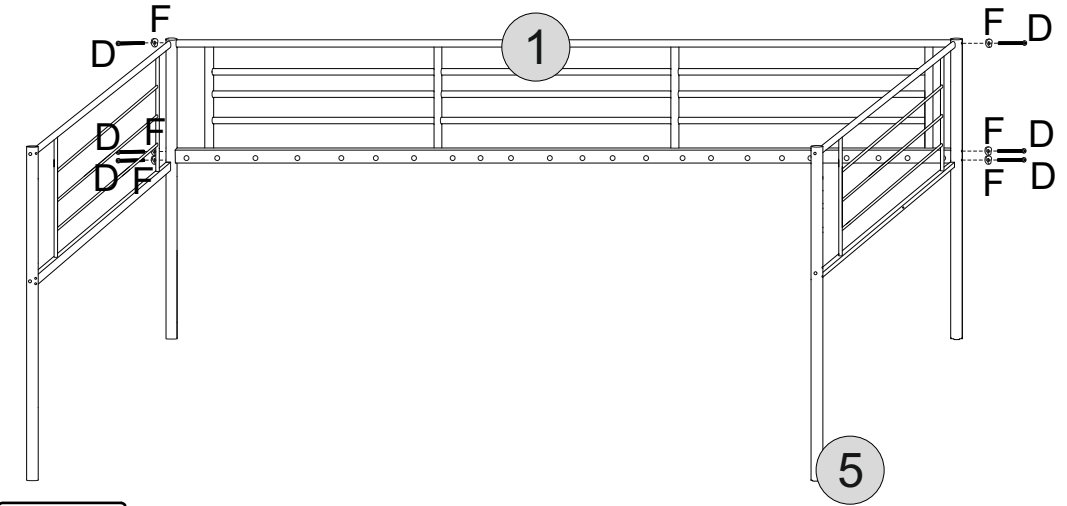
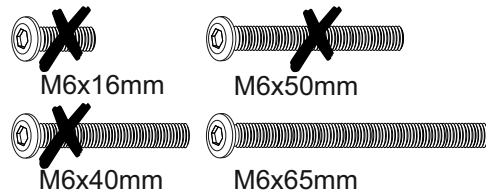

DO NOT FULLY TIGHTEN THE BOLTS AT THIS STAGE !!

STEP 4

PARTS REQUIRED

6 - CENTRE RAIL x1

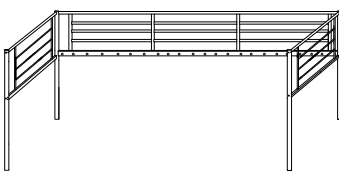

HARDWARE REQUIRED

B		02
E		02

TOOLS REQUIRED

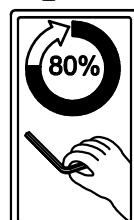
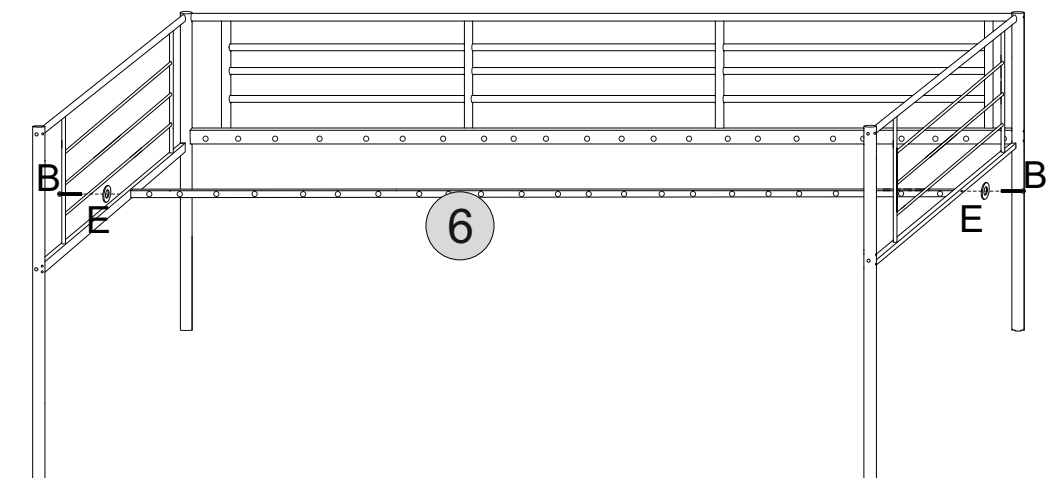
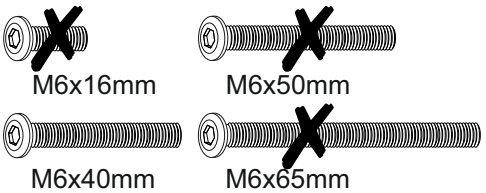

DO NOT FULLY TIGHTEN THE BOLTS AT THIS STAGE !!

STEP 5

PARTS REQUIRED

7 - SLATS x21

8 - FIXED SLATS x2

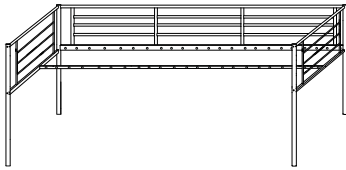

HARDWARE REQUIRED

A  02

E  02

TOOLS REQUIRED

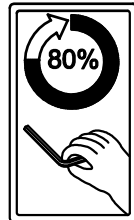
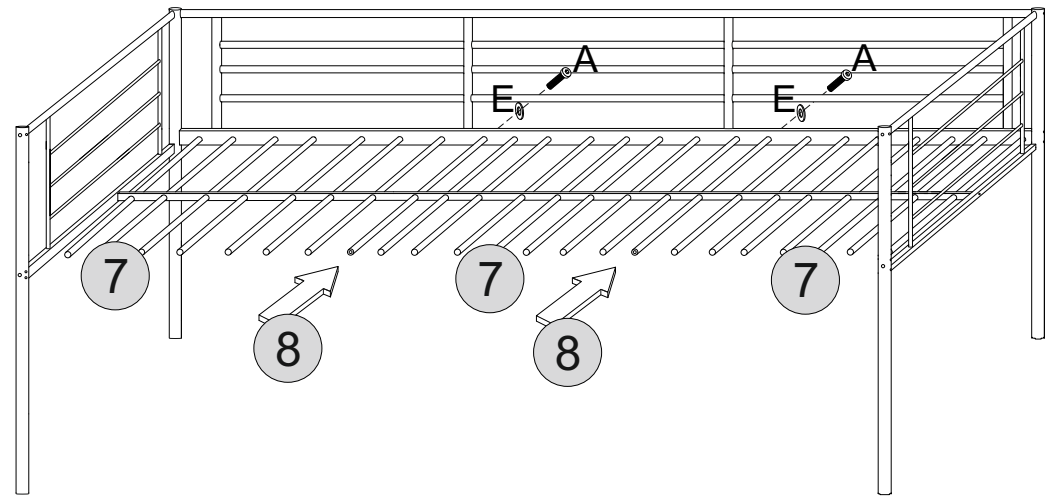
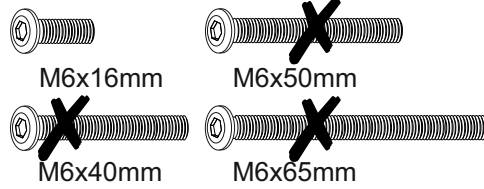

DO NOT FULLY TIGHTEN THE BOLTS AT THIS STAGE !!

STEP 6

PARTS REQUIRED

2 - FRONT GUARDRAIL x1

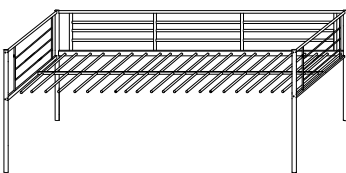

HARDWARE REQUIRED

A  02

D  05

E  02

F  05

TOOLS REQUIRED

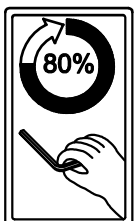
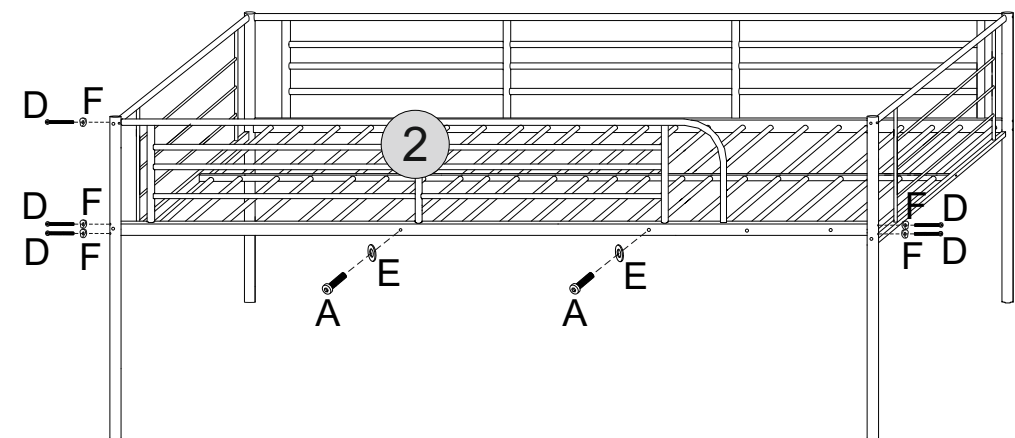
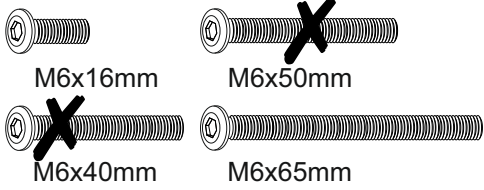

DO NOT FULLY TIGHTEN THE BOLTS AT THIS STAGE !!

STEP 7

PARTS REQUIRED

9 - LADDER SIDE x2

10 - LADDER STEPS x2

HARDWARE REQUIRED

B  04

F  04

TOOLS REQUIRED

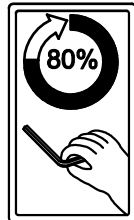
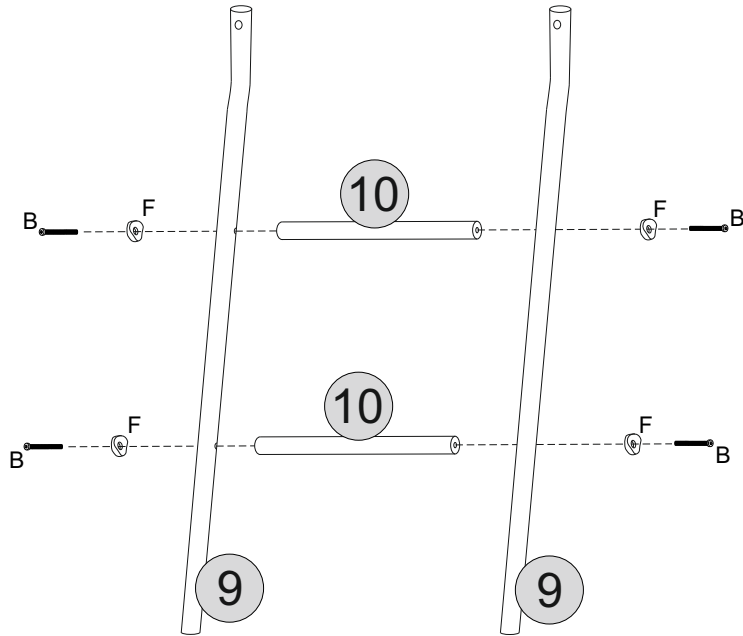
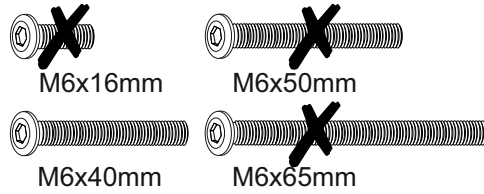

DO NOT FULLY TIGHTEN THE BOLTS AT THIS STAGE !!

STEP 8

PARTS REQUIRED

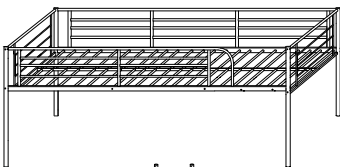

HARDWARE REQUIRED

C  02

F  02

H  02

TOOLS REQUIRED

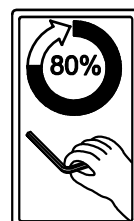
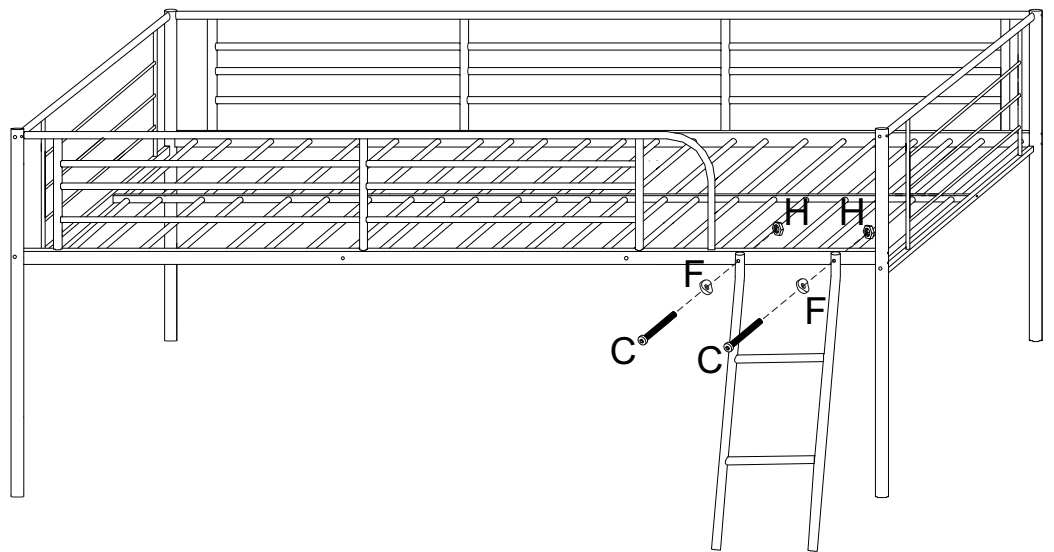
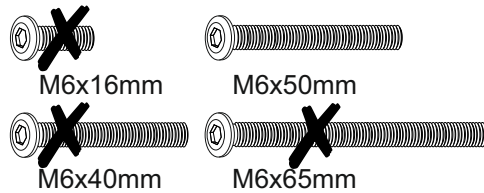
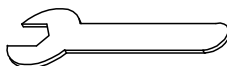

DO NOT FULLY TIGHTEN THE BOLTS AT THIS STAGE !!

STEP 9

PARTS REQUIRED

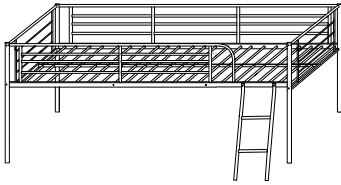

HARDWARE REQUIRED

TOOLS REQUIRED

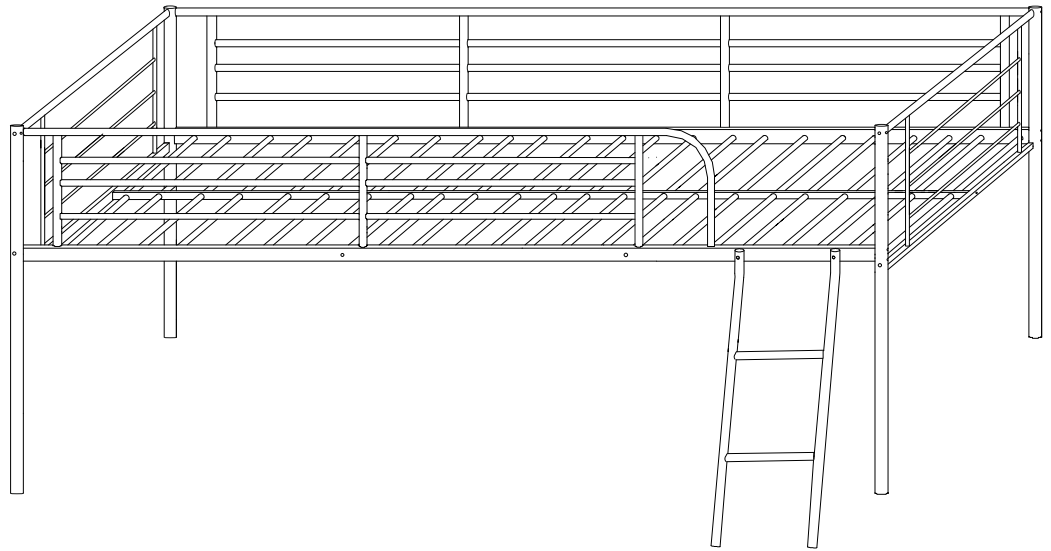

PLEASE NOW FULLY TIGHTEN ALL BOLTS !!!

STEP 10

PARTS REQUIRED

HARDWARE REQUIRED

TOOLS REQUIRED

