

# KELLY 3' BED ASSEMBLY INSTRUCTIONS

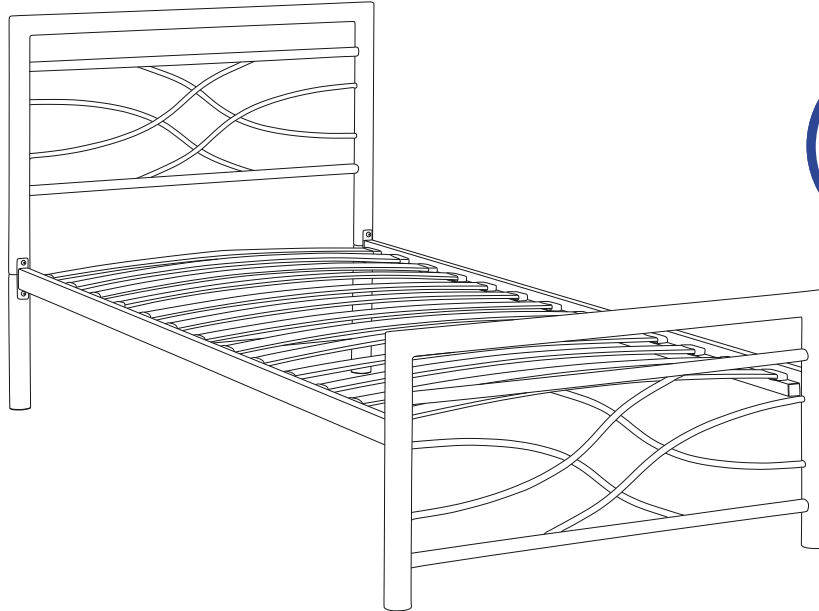

## **IMPORTANT FOR DOMESTIC USE ONLY PLEASE READ BEFORE YOU CONTINUE FURTHER**

**THE PRODUCT YOU HAVE PURCHASED WILL GIVE YOU MANY YEARS OF SERVICE IF YOU FOLLOW THE GUIDELINES FOR ITS SAFE ASSEMBLY AND PERIODIC MAINTENANCE AND CLEANING.**

**DO NOT USE ANY TOOLS OTHER THAN THOSE SHOWN.**

**ANY SPANNERS OR ALLEN KEYS REQUIRED ARE INCLUDED WITH THE FITTINGS KIT.**

**DO NOT FOR ANY REASON USE A POWER TOOL TO ASSEMBLE THIS PRODUCT. ITS USE WILL INVALIDATE ANY CLAIM YOU MAY HAVE AND COULD MAKE THIS PRODUCT UNSAFE .**

**DEPENDING ON THE AMOUNT OF USE THIS PRODUCT RECEIVES IT MAY BE NECESSARY TO TIGHTEN UP THE FIXINGS FROM TIME TO TIME, THIS IS COMPLETELY NORMAL FOR ANY FLATPACK FURNITURE.**



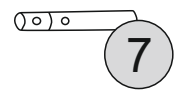
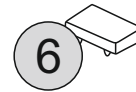
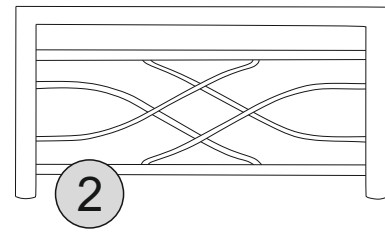
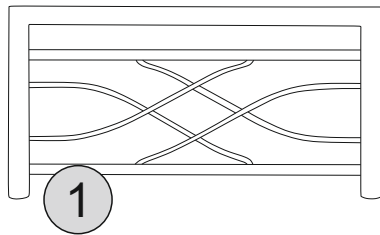

**FOR CLEANING, YOU MAY USE A DAMP CLOTH (NOT WET) DO NOT USE POLISH, DETERGENT OR CHEMICAL CLEANERS.**



## PARTS LIST

Part Number	Part Code	Part Description	Quantity	Carton
1	S200-201-014-WJ1-01	Headboard	1	1
2	S200-201-014-WJ1-02	Footboard	1	1
3	S200-201-014-WJ1-03	Crossbar	1	1
4	S200-201-014-WJ1-04	Siderail	2	2
5	S200-201-014-WJ1-05	Wooden Slat	13	1
6	S200-201-014-WJ1-06	Slat Caps	26	1
7	S200-201-014-WJ1-07	Leg Extension	2	1

## HARDWARE LIST

No	Part Name		Qty	Carton
A	M6 x 15MM BOLTS		x8	1/1
B	M6 x 45MM BOLTS		x4	1/1
C	METAL WASHER		x4	1/1
D	M6 INSERT NUTS		x4	1/1
E	M4 ALLEN KEY		x2	1/1

**PLEASE CHECK THAT YOU HAVE ALL THE PARTS LISTED BEFORE YOU START ASSEMBLING, IF YOU DO FIND THAT SOMETHING IS MISSING, DO NOT CONTINUE ASSEMBLY. PLEASE CONTACT YOUR SUPPLIER IMMEDIATELY.**

# STEP 1

## PARTS REQUIRED

1 - HEADBOARD x1

2 - FOOTBOARD x1

4 - SIDERAIL x2

7 - LEG EXTENSION x2

## HARDWARE REQUIRED

A  04

B  04

D  04

E  04

## TOOLS REQUIRED

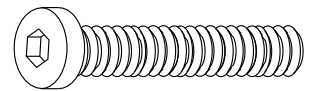
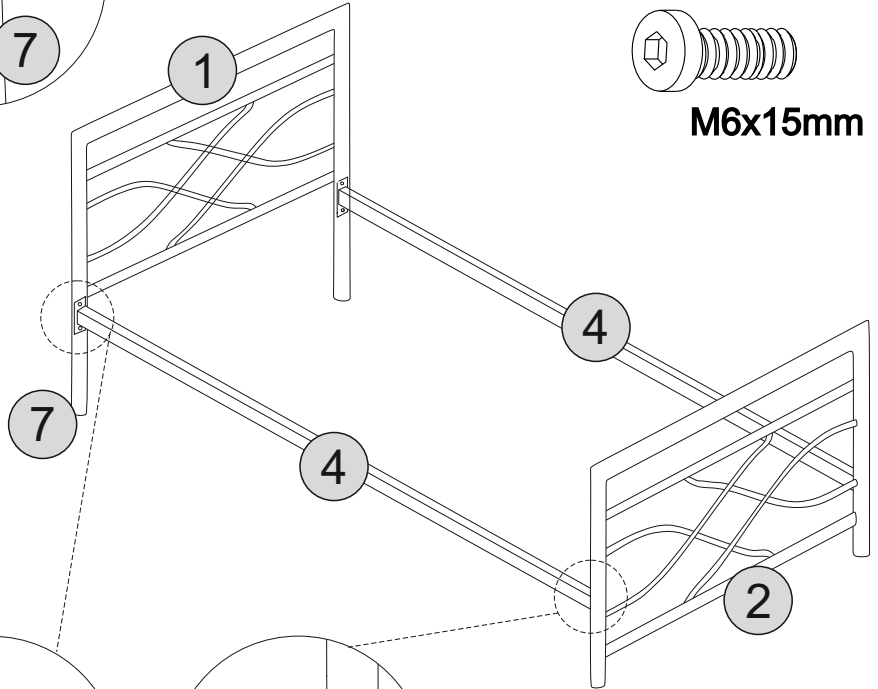
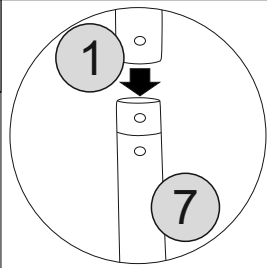

M6x45mm

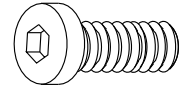

M6x15mm

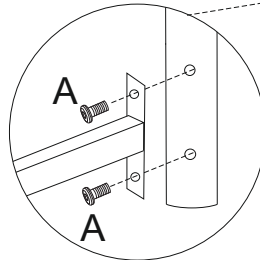
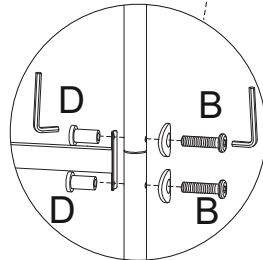

# STEP 2

## PARTS REQUIRED

3 - CROSSBAR x1

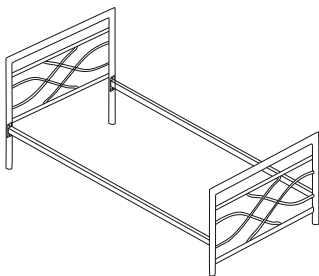

## HARDWARE REQUIRED

A  04

## TOOLS REQUIRED

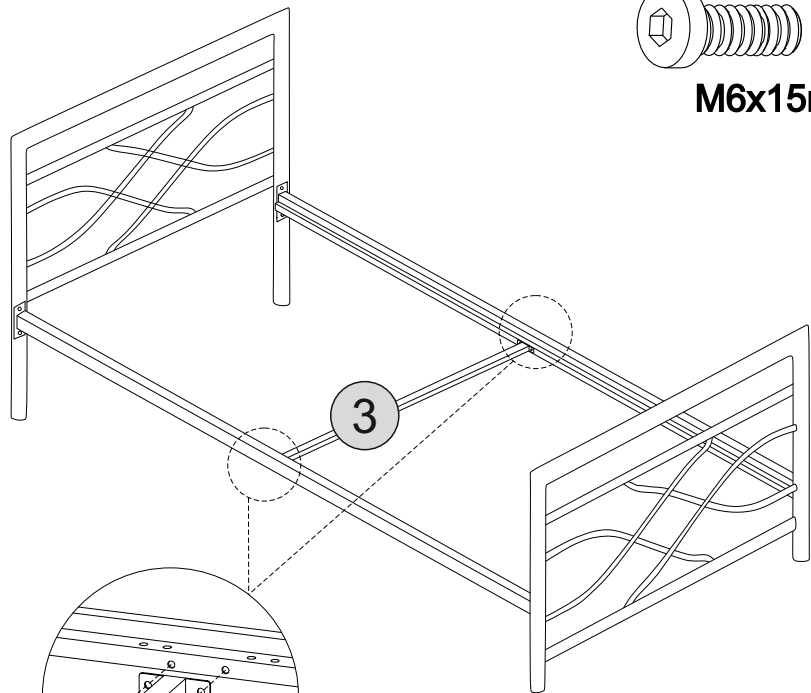

M6x45mm

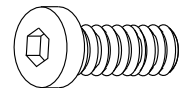

M6x15mm

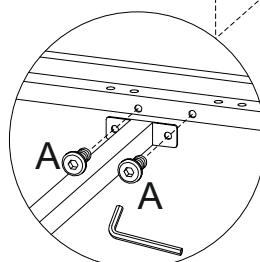

## STEP 3

### PARTS REQUIRED

5 - WOODEN SLAT x13

6 - SLAT CAPS x26

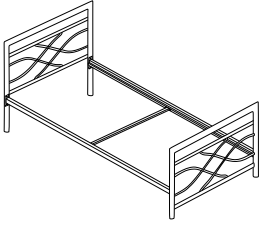

### HARDWARE REQUIRED

### TOOLS REQUIRED

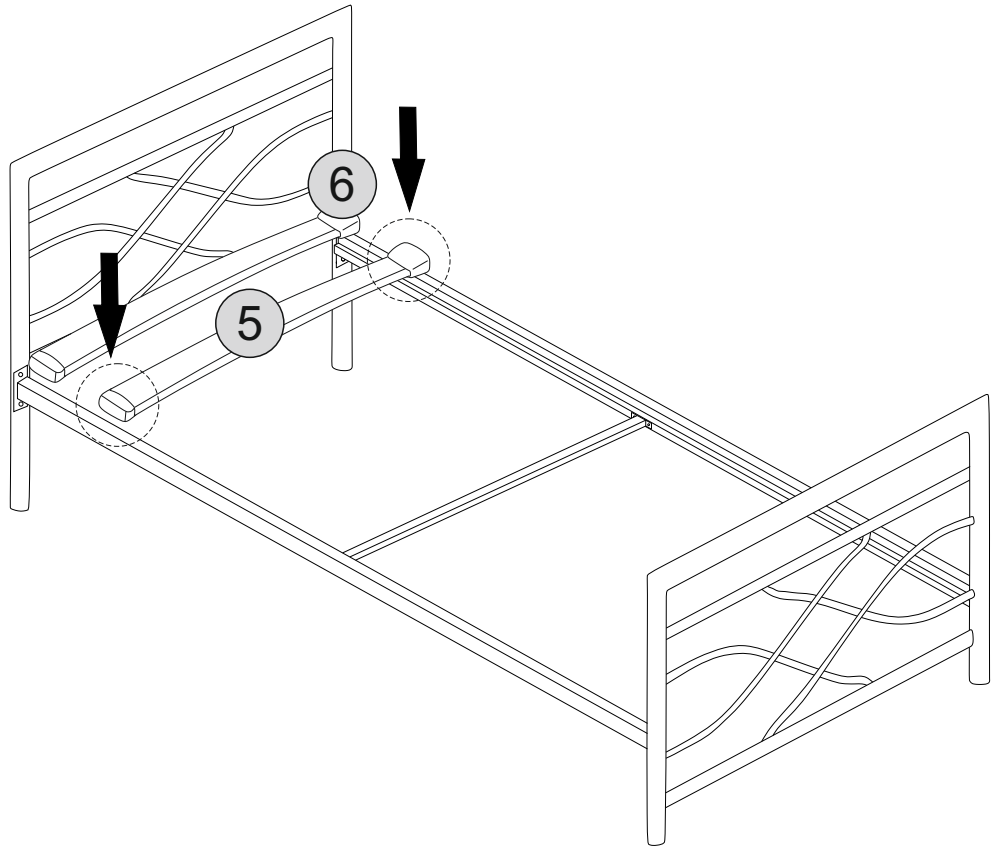

## STEP 4

### PARTS REQUIRED

### HARDWARE REQUIRED

### TOOLS REQUIRED

